



TO-92L Plastic-Encapsulate Transistors

2SA684 TRANSISTOR (PNP)

FEATURES

- Automatic Insertion by Radial Taping Possible
- Complementary Pair with 2SC1384

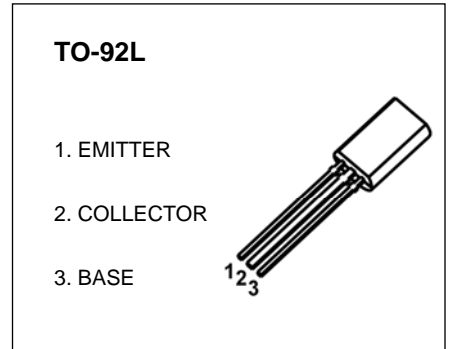

MARKING



A684=Device code
Solid dot = Green molding compound device,
if none, the normal device
XXX=Code

Equivalent Circuit

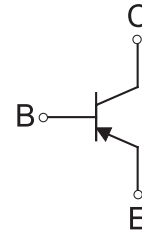

ORDERING INFORMATION

Part Number	Package	Packing Method	Pack Quantity
2SA684	TO-92L	Bulk	500pcs/Bag
2SA684-TA	TO-92L	Tape	2000pcs/Box

MAXIMUM RATINGS(T_a=25°C unless otherwise noted)

Symbol	Parameter	Value	Unit
V _{CB0}	Collector-Base Voltage	-60	V
V _{CE0}	Collector-Emitter Voltage	-50	V
V _{EB0}	Emitter-Base Voltage	-5	V
I _C	Collector Current -Continuous	-1	A
P _C	Collector Power Dissipation	0.75	W
T _J , T _{stg}	Operation Junction and Storage Temperature Range	-55~150	°C

ELECTRICAL CHARACTERISTICS

$T_a=25^\circ\text{C}$ unless otherwise specified

Parameter	Symbol	Test conditions	Min	Typ	Max	Unit
Collector-base breakdown voltage	$V_{(BR)CBO}$	$I_C=-10\mu\text{A}$, $I_E=0$	-60			V
Collector-emitter breakdown voltage	$V_{(BR)CEO}$	$I_C=-2\text{mA}$, $I_B=0$	-50			V
Emitter-base breakdown voltage	$V_{(BR)EBO}$	$I_E=-10\mu\text{A}$, $I_C=0$	-5			V
Collector cut-off current	I_{CBO}	$V_{CB}=-20\text{V}$, $I_E=0$			-0.1	μA
DC current gain	$h_{FE(1)}$	$V_{CE}=-10\text{V}$, $I_C=-500\text{mA}$	85		340	
	$h_{FE(2)}$	$V_{CE}=-5\text{V}$, $I_C=-1\text{A}$	50			
Collector-emitter saturation voltage	$V_{CE(sat)}$	$I_C=-500\text{mA}$, $I_B=-50\text{mA}$		-0.2	-0.4	V
Base-emitter saturation voltage	$V_{BE(sat)}$	$I_C=-500\text{mA}$, $I_B=-50\text{mA}$		-0.85	-1.2	V
Transition frequency	f_T	$V_{CE}=-10\text{V}$, $I_E=50\text{mA}$, $f=200\text{MHz}$		200		MHz
Collector output capacitance	C_{ob}	$V_{CB}=-10\text{V}$, $I_E=0$, $f=1\text{MHz}$		20	30	pF

CLASSIFICATION OF $h_{FE(1)}$

Rank	Q	R	S
Range	85-170	120-240	170-340

Typical Characteristics

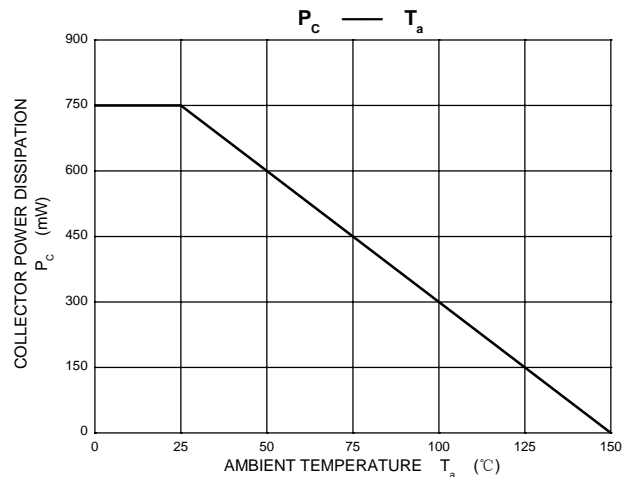
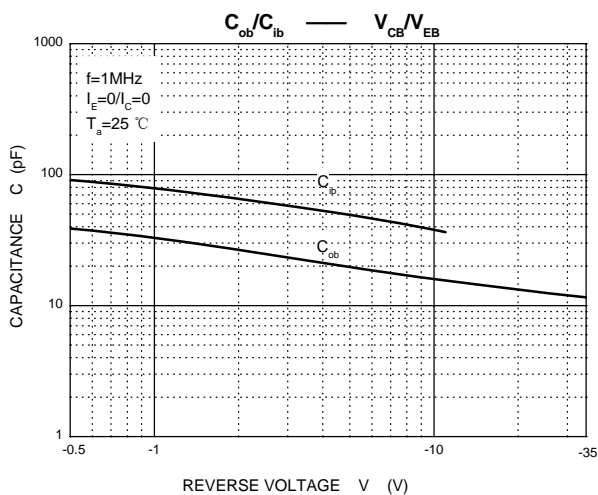
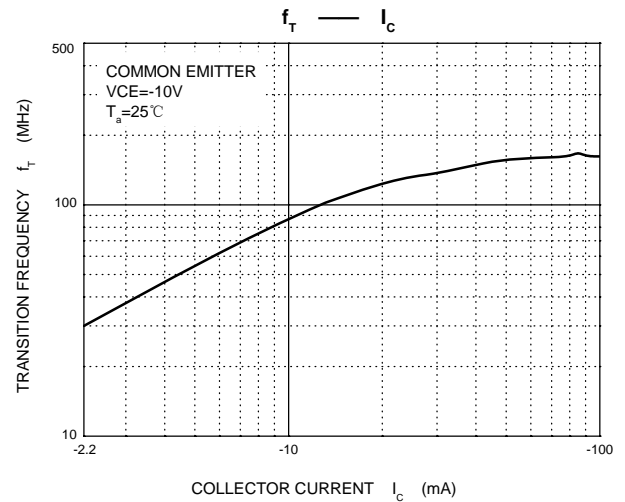
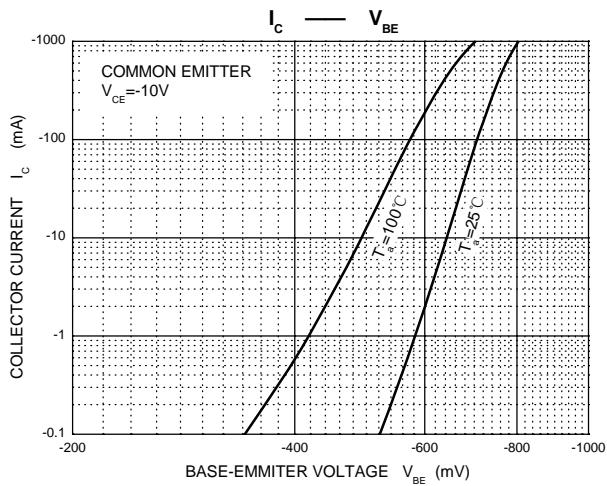
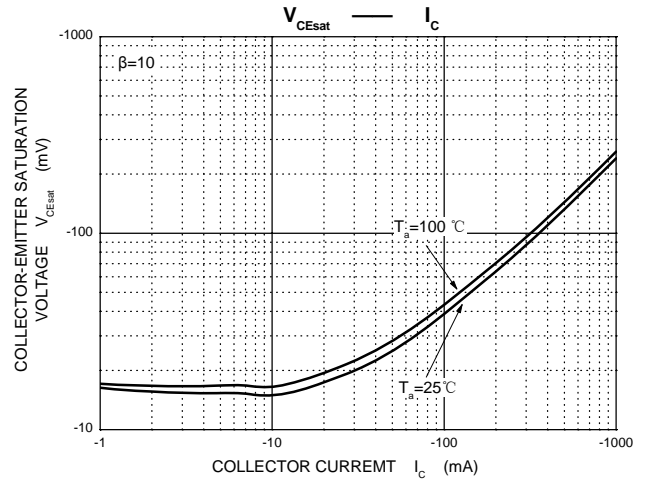
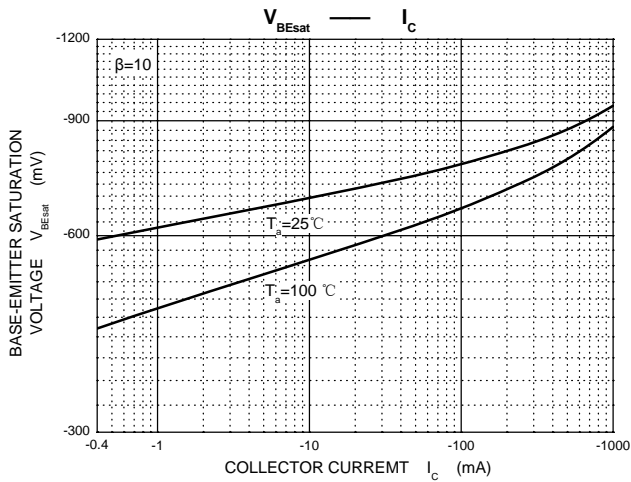
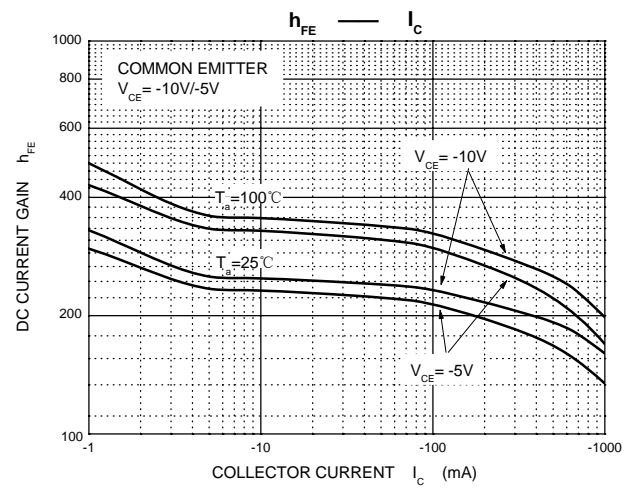
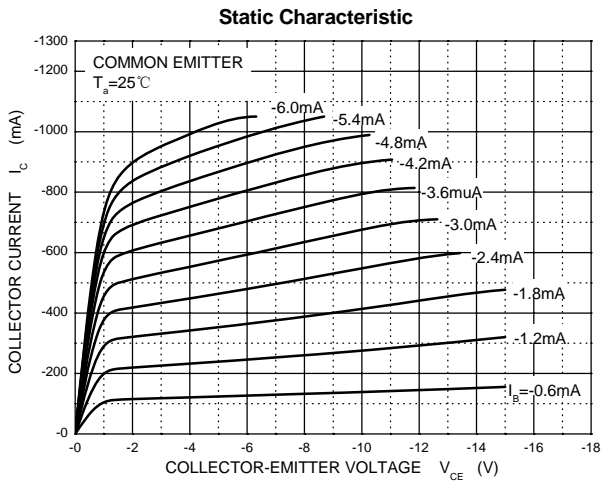

TO-92L Package Outline Dimensions

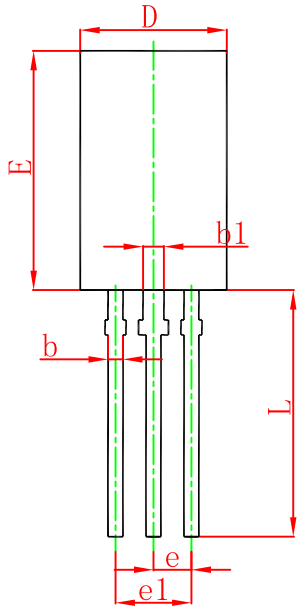
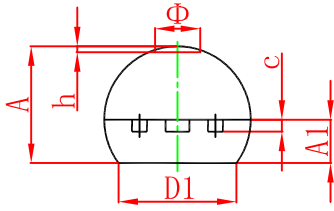

Symbol	Dimensions In Millimeters		Dimensions In Inches	
	Min.	Max.	Min.	Max.
A	3.750	4.050	0.148	0.159
A1	1.280	1.580	0.050	0.062
b	0.380	0.550	0.015	0.022
b1	0.620	0.780	0.024	0.031
c	0.350	0.450	0.014	0.018
D	4.750	5.050	0.187	0.199
D1	4.000		0.157	
E	7.850	8.150	0.309	0.321
e	1.270 TYP.		0.050 TYP.	
e1	2.440	2.640	0.096	0.104
L	13.800	14.200	0.543	0.559
Φ		1.600		0.063
h	0.000	0.300	0.000	0.012

TO-92L Suggested Pad Layout

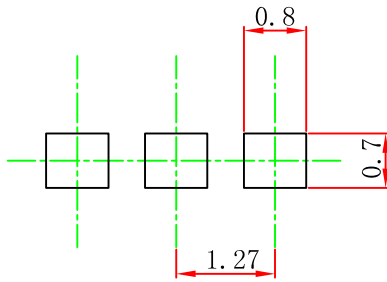

Note:

1. Controlling dimension: in millimeters.
2. General tolerance: $\pm 0.05\text{mm}$.
3. The pad layout is for reference purposes only.

NOTICE

JSCJ reserves the right to make modifications, enhancements, improvements, corrections or other changes without further notice to any product herein. JSCJ does not assume any liability arising out of the application or use of any product described herein.

TO-92L PACKAGE TAPING DIMENSION

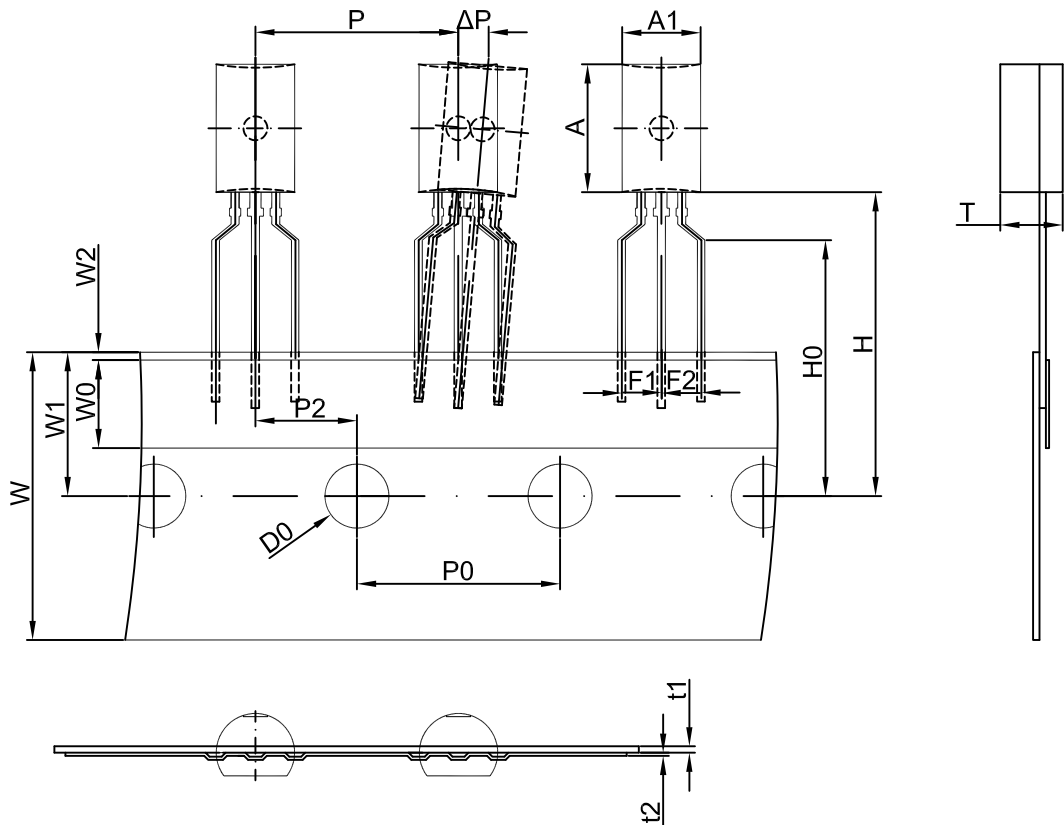

Dimensions are in millimeter

A1	A	T	P	P0	P2	F1	F2	W
4.9	8.0	3.9	12.7	12.7	6.35	2.5	2.5	18.0
W0	W1	W2	H	H0	D0	t1	t2	ΔP
6.0	9.0	1.0	19.0	16.0	4.0	0.4	0.2	0

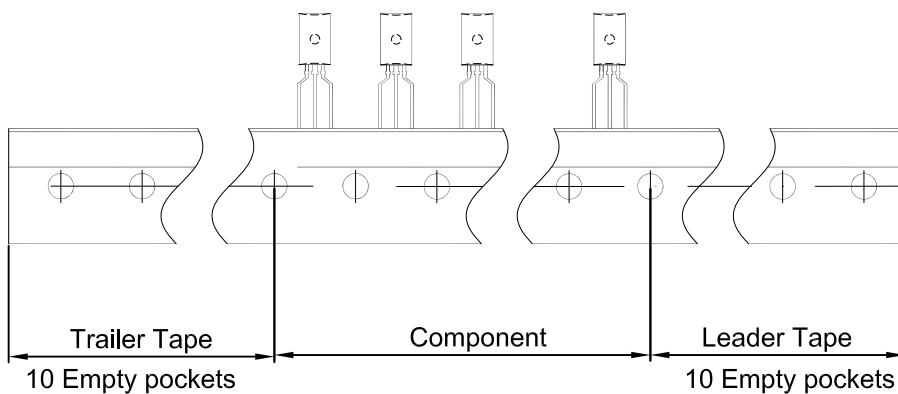

Package	Box	Box Size(mm)	Carton	Carton Size(mm)
TO-92L	2000 pcs	333×203×42	20,000 pcs	493×400×264